

<HVIC>

M81747JFP

600V HIGH VOLTAGE HALF BRIDGE DRIVER (for Automotive)

DESCRIPTION

M81747JFP is high voltage Power MOSFET and IGBT gate driver for half bridge applications.

FEATURES

- Floating Supply Voltage 600V
- Output Current +200mA/-350mA(Typ.)
- Half Bridge Driver
- SOP-8 Package

APPLICATIONS

MOSFET and IGBT module driver.

PIN CONFIGURATION (TOP VIEW)

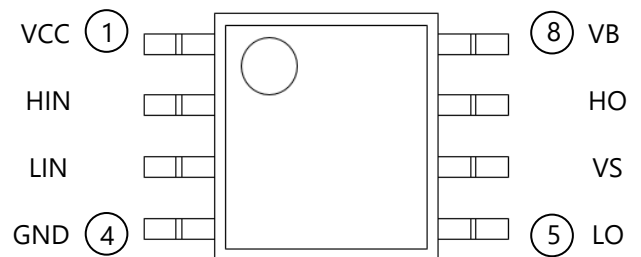

Outline:SOP8

BLOCK DIAGRAM

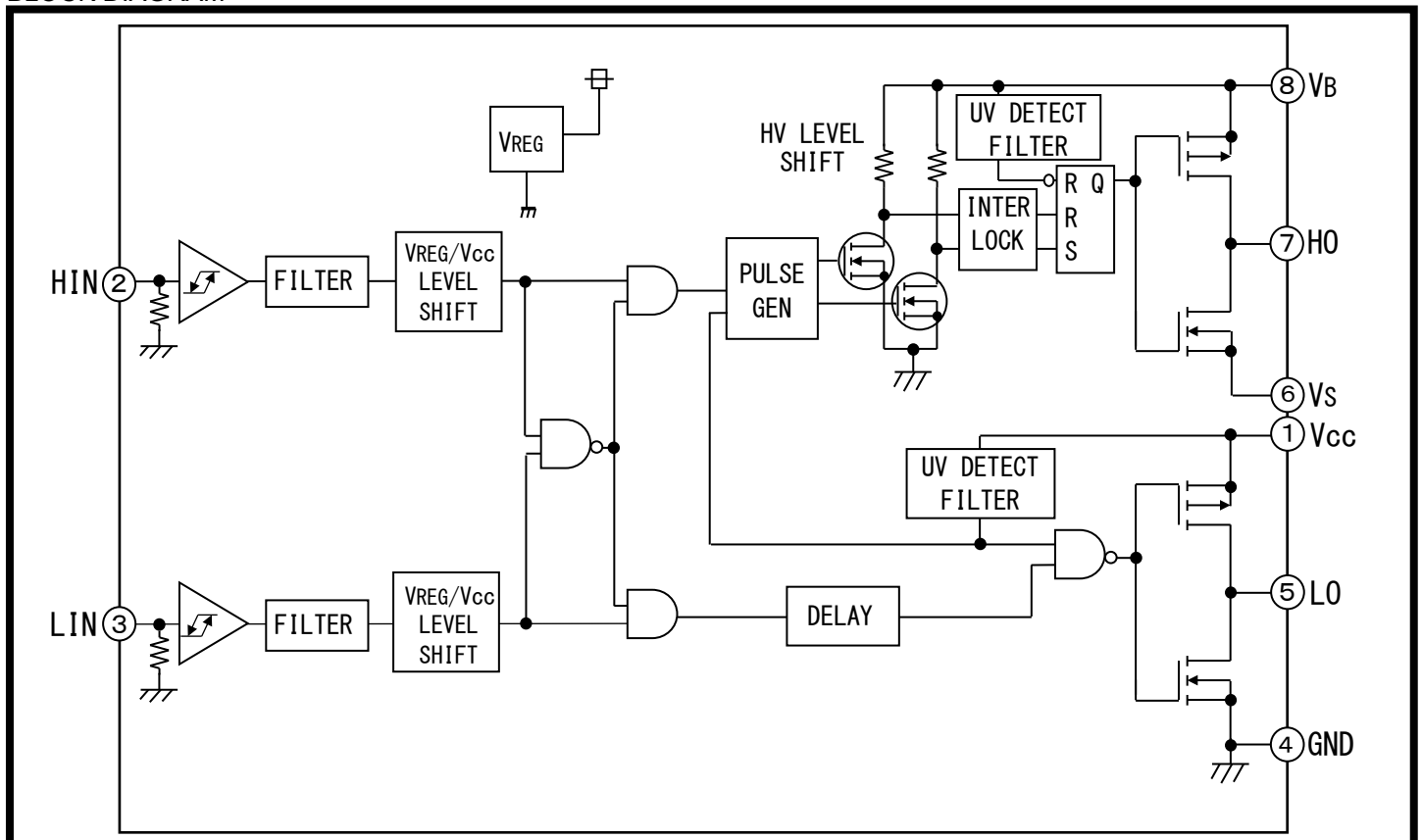

<HVIC>

M81747JFP

600V HIGH VOLTAGE HALF BRIDGE DRIVER (for Automotive)

ABSOLUTE MAXIMUM RATINGS (Ta = 25°C unless otherwise specified)

Symbol	Parameter	Test conditions	Ratings	Unit
V _B	High Side Floating Supply Absolute Voltage		- 0.5 ~ 624	V
V _S	High Side Floating Supply Offset Voltage		V _B - 24 ~ V _B + 0.5	V
V _{BS}	High Side Floating Supply Voltage	V _{BS} = V _B - V _S	- 0.5 ~ 24	V
V _{HO}	High Side Output Voltage		V _S - 0.5 ~ V _B + 0.5	V
V _{CC}	Low Side Fixed Supply Voltage		- 0.5 ~ 24	V
V _{LO}	Low Side Output Voltage		- 0.5 ~ V _{CC} + 0.5	V
V _{IN}	Logic Input Voltage	HIN,LIN Terminal	- 0.5 ~ V _{CC} + 0.5	V
P _d	Package Power Dissipation	Ta = 25°C ,On Board	0.6	W
Kθ	Linear Derating Factor	Ta > 25°C ,On Board	4.8	mW/°C
Rth(j-c)	Junction-Case Thermal Resistance		50	°C/W
T _j	Junction Temperature		- 40 ~ 150	°C
T _{opr}	Operation Temperature		- 40 ~ 125	°C
T _{stg}	Storage Temperature	On Board	- 40 ~ 150	°C
TL	Solder Reflow Condition	Pb-free	255:10s, max 260	°C

RECOMMENDED OPERATING CONDITIONS

Symbol	Parameter	Test conditions	Limits			Unit
			Min.	Typ.	Max.	
V _B	High Side Floating Supply Absolute Voltage		V _S + 10	—	V _S + 20	V
V _S	High Side Floating Supply Offset Voltage	V _B > 10V	- 5	—	500	V
V _{BS}	High Side Floating Supply Voltage	V _{BS} = V _B - V _S	10	—	20	V
V _{HO}	High Side Output Voltage		V _S	—	V _B	V
V _{CC}	Low Side Fixed Supply Voltage		10	—	20	V
V _{LO}	Low Side Output Voltage		0	—	V _{CC}	V
V _{IN}	Logic Input Voltage	HIN,LIN Terminal	0	—	7	V

Note: For proper operation, the device should be used within the recommended conditions

THERMAL DERATING FACTOR CHARACTERISTIC (MAXIMUM RATING)

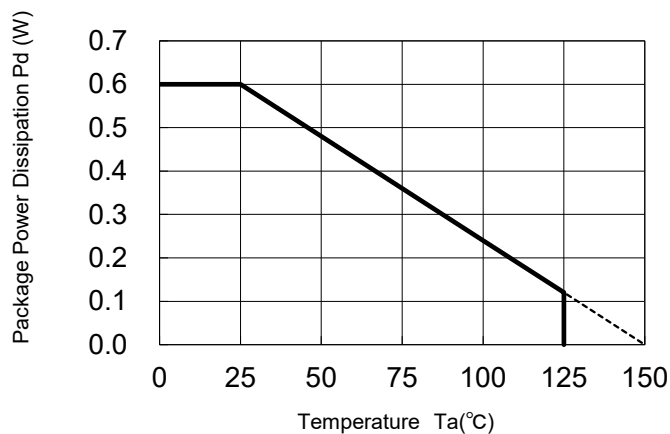

M81747JFP

600V HIGH VOLTAGE HALF BRIDGE DRIVER (for Automotive)

ELECTRICAL CHARACTERISTICS (Ta=-40~125°C, VCC=VBS (=VB-VS)=15V, unless otherwise specified)

Symbol	Parameter	Test conditions	Limits			Unit
			Min.	Typ.*1	Max.	
I_{FS}	Floating Supply Leakage Current	$V_B = V_S = 600V, 25^\circ C$	—	—	1.0	μA
I_{BS}	V_{BS} Standby Current	HIN = LIN = 0V	—	0.2	0.5	mA
I_{CC}	V_{CC} Standby Current	HIN = LIN = 0V	0.2	0.6	1.0	mA
V_{OH}	High Level Output Voltage	$I_O = -20mA, HO, LO$ Terminal	13.6	14.2	—	V
V_{OL}	Low Level Output Voltage	$I_O = 20mA, HO, LO$ Terminal	—	0.3	0.6	V
V_{IH}	High Level Input Threshold Voltage *2	HIN, LIN Terminal	4.0	—	—	V
V_{IL}	Low Level Input Threshold Voltage *3	HIN, LIN Terminal	—	—	0.8	V
I_{IH}	High Level Input Bias Current	$V_{IN} = 5V, HIN, LIN$ Terminal	25	50	100	μA
I_{IL}	Low Level Input Bias Current	$V_{IN} = 0V, HIN, LIN$ Terminal	—	—	2	μA
V_{BSuvr}	V_{BS} Supply UV Reset Voltage		7.0	8.9	9.8	V
V_{BSuvt}	V_{BS} Supply UV Trip Voltage		7.4	8.2	9.0	V
V_{BSuvh}	V_{BS} Supply UV Hysteresis Voltage		0.5	0.7	—	V
t_{VBSuv}	V_{BS} Supply UV Filter Time		—	7.5	—	μs
V_{CCuvr}	V_{CC} Supply UV Reset Voltage		7.0	8.9	9.8	V
V_{CCuvt}	V_{CC} Supply UV Trip Voltage		7.4	8.2	9.0	V
V_{CCuvh}	V_{CC} Supply UV Hysteresis Voltage		0.5	0.7	—	V
t_{VCCuv}	V_{CC} Supply UV Filter Time		—	7.5	—	μs
I_{OH}	Output High Level Short Circuit Pulsed Current	$V_O = 0V, V_{IN} = 5V, PW < 10\mu s$ *4	120	200	—	mA
I_{OL}	Output Low Level Short Circuit Pulsed Current	$V_O = 15V, V_{IN} = 0V, PW < 10\mu s$ *4	250	350	—	mA
R_{OH}	Output High Level On Resistance	$I_O = -20mA, R_{OH} = (V_{CC} - V_{OH}) / I_O$	—	40	70	Ω
R_{OL}	Output Low Level On Resistance	$I_O = 20mA, R_{OL} = V_{OL} / I_O$	—	15	30	Ω
$t_{dLH}(HO)$	High Side Turn-On Propagation Delay	CL = 1000pF between HO- V_S	—	450	750	ns
$t_{dHL}(HO)$	High Side Turn-Off Propagation Delay	CL = 1000pF between HO- V_S	—	450	750	ns
t_{rH}	High Side Turn-On Rise Time	CL = 1000pF between HO- V_S	—	130	220	ns
t_{fH}	High Side Turn-Off Fall Time	CL = 1000pF between HO- V_S	—	50	80	ns
$t_{dLH}(LO)$	Low Side Turn-On Propagation Delay	CL = 1000pF between LO-GND	—	450	750	ns
$t_{dHL}(LO)$	Low Side Turn-Off Propagation Delay	CL = 1000pF between LO-GND	—	450	750	ns
t_{rL}	Low Side Turn-On Rise Time	CL = 1000pF between LO-GND	—	130	220	ns
t_{fL}	Low Side Turn-Off Fall Time	CL = 1000pF between LO-GND	—	50	80	ns
Δt_{dLH}	Turn-On Propagation Delay Matching	$ t_{dLH}(HO) - t_{dLH}(LO) $	—	0	40	ns
Δt_{dHL}	Turn-Off Propagation Delay Matching	$ t_{dHL}(HO) - t_{dHL}(LO) $	—	0	40	ns
tinon	Turn-On Input Filter Time	Convex Pulse, HIN, LIN Terminal	150	250	350	ns
		Concave Pulse, HIN, LIN Terminal	250	350	450	ns
tinoff	Turn-Off Input Filter Time	Convex Pulse, HIN, LIN Terminal	150	250	350	ns
		Concave Pulse, HIN, LIN Terminal	250	350	450	ns
ΔP_{wIO}	Differences at Pulse Width between Input and Output	$ P_w(IN) - P_w(OUT) $	—	—	100	ns

*1 Typ. is not specified.

*2 Please set High level input voltage more than the minimum value of limits.

*3 Please set Low level input voltage less than the maximum value of limits.

*4 The short circuit pulse cannot be continuously.

M81747JFP

600V HIGH VOLTAGE HALF BRIDGE DRIVER (for Automotive)

INPUT/OUTPUT TIMING DIAGRAM

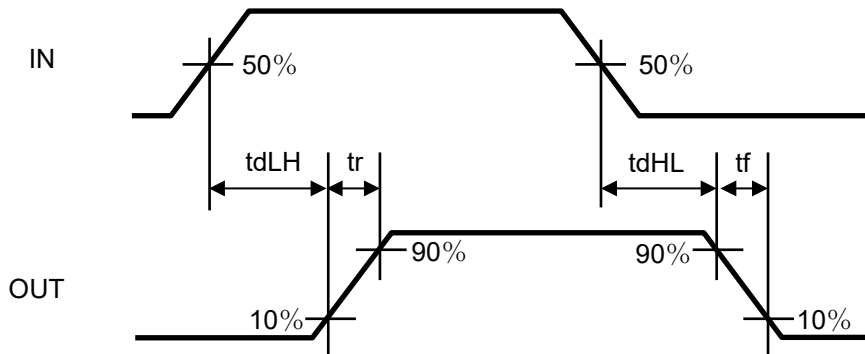

FUNCTION TABLE (X:H or L)

HIN	LIN	V _{BS} UV	V _{CC} UV	HO	LO	Behavioral state
H→L	L	H	H	L	L	HO = L, LO = L
H→L	H	H	H	L	H	LO = H
L→H	L	H	H	H	L	HO = H
L→H	H	H	H	L	L	HO = L, LO = L
X	L	L	H	L	L	HO = L when V _{BS} UV is detected
H→L	H	L	H	L	H	LO = H when V _{BS} UV is detected
L→H	H	L	H	L	L	HO = L, LO = L when V _{BS} UV is detected
H→L	X	H	L	L	L	LO = L when V _{CC} UV is detected
L→H	X	H	L	L	L	HO = L, LO = L when V _{CC} UV is detected

Note1 : "L" state of VBS UV, VCC UV means that VCC (VBS) Supply become under UV trip voltage.

Note2 : In the case of both input signals (HIN and LIN) are "H", output signals (HO and LO) become "L".

Note3 : X(HIN): L→H or H→L. X(LIN):H or L.

Note4 : Output Signal (HO) is triggered by the edge of input signal.

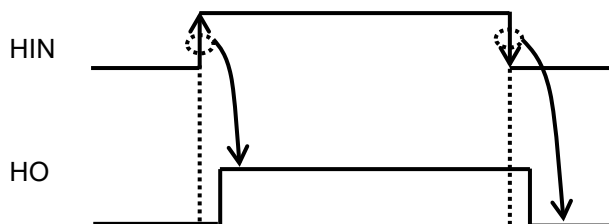

M81747JFP

600V HIGH VOLTAGE HALF BRIDGE DRIVER (for Automotive)

FUNCTION TIMING DIAGRAM

1. Input/Output Timing Diagram

High Active, in the case of both input signals (HIN, LIN) are "H", output signals (HO, LO) become "L".

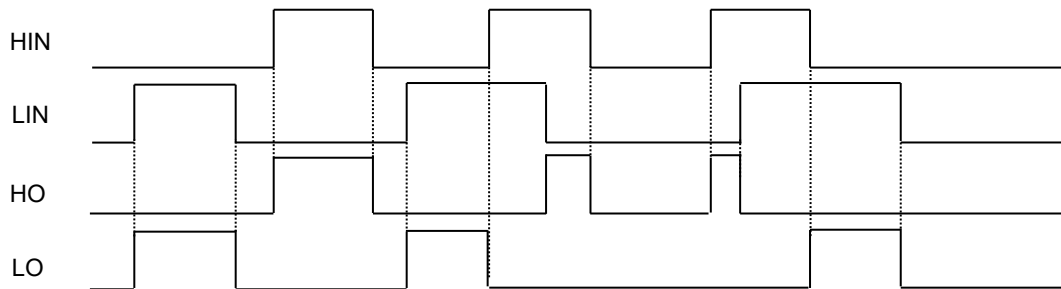

2. V_{CC} (V_{BS}) Supply Under Voltage (UV) Lockout Timing Diagram

If V_{CC} supply voltage drops below UV trip voltage (V_{CCuvt}) for V_{CC} supply UV filter time, LO output signal is shut down. And then, if V_{CC} supply voltage rises over UV reset voltage, LO will return to the usual operation mode.

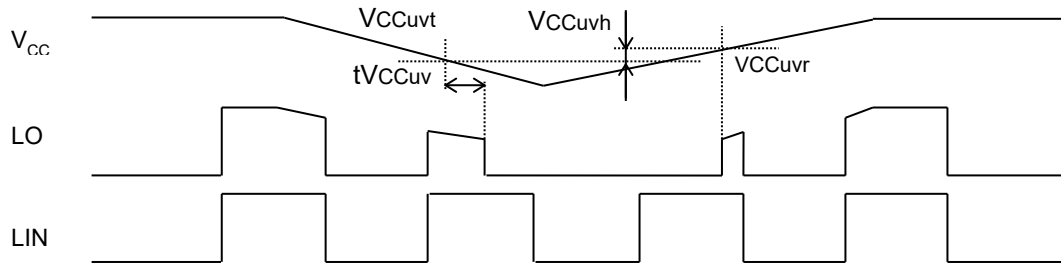

If V_{CC} supply voltage drops below UV trip voltage (V_{CCuvt}) for V_{CC} supply UV filter time, HO output signal is shut down. And then, if V_{CC} supply voltage rises over UV reset voltage, HO will return to the usual operation mode.

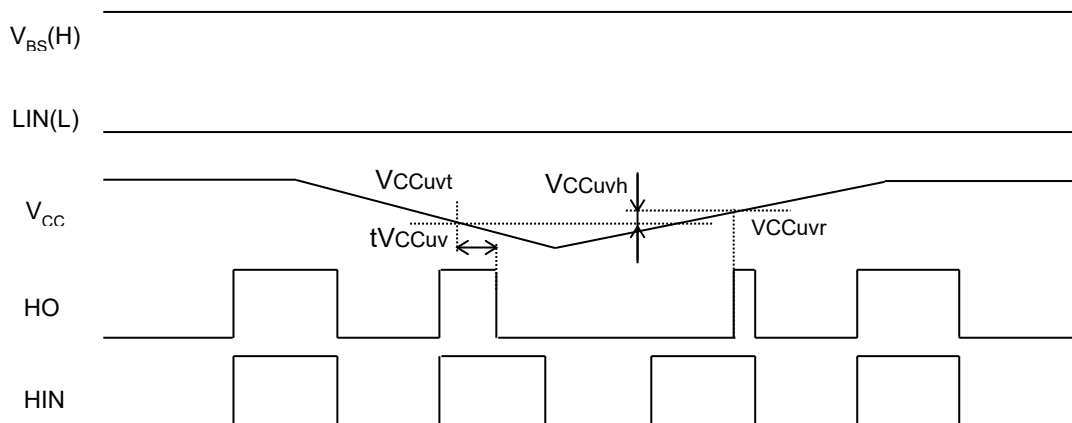

M81747JFP

600V HIGH VOLTAGE HALF BRIDGE DRIVER (for Automotive)

If VBS supply voltage drops below UV trip voltage (V_{BSuvt}) for VBS supply UV filter time, HO output signal is shut down. And then, if VBS supply voltage rises over UV reset voltage, HO will respond to the next active HIN signal(L→H).

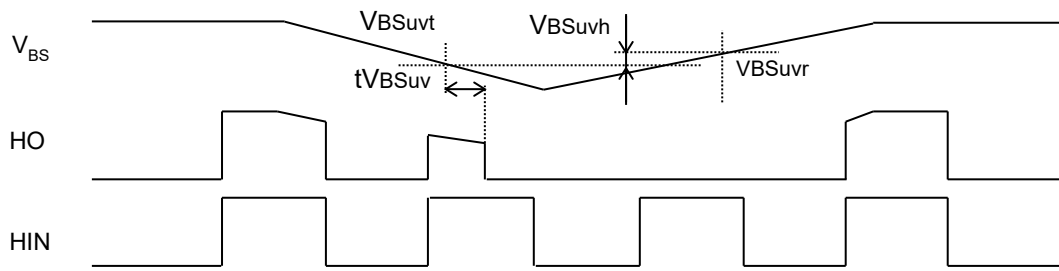

3. Input Filter Timing Diagram

If the pulse that is longer than Input Filter Time has been entered, it will output a signal corresponding to the input after Turn-On Propagation Delay from rising edge or falling edge of the input signal.

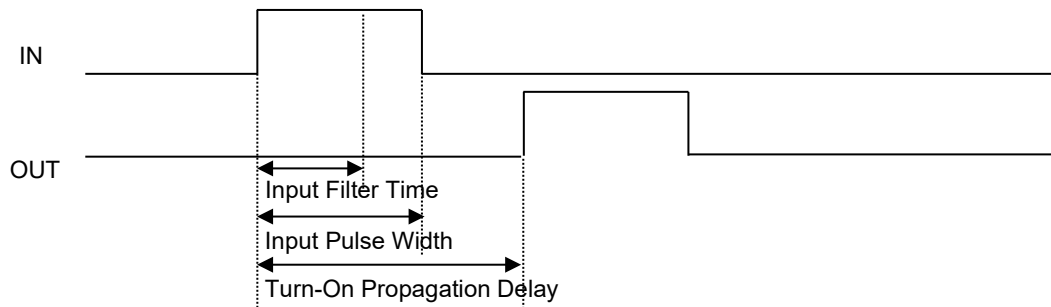

If the pulse that is shorter than Input Filter Time has been entered, output will hold the state by the input filter protection.

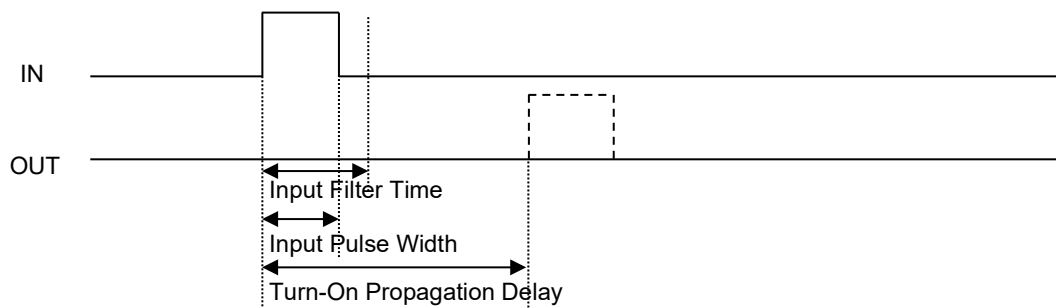

M81747JFP

600V HIGH VOLTAGE HALF BRIDGE DRIVER (for Automotive)

NOTES

1) Allowable supply voltage transient

It is recommended to supply V_{CC} firstly and supply V_{BS} secondly. In the case of shutting off supply voltage, please shut off V_{BS} firstly and shut off V_{CC} secondly.

When applying V_{CC} and V_{BS} , power supply should be applied slowly.

If it rises rapidly, output signal (HO or LO) may be malfunction.

2) Supply voltage start up or restart after shut down

If V_{CC} supply is less than 10V(outside of RECOMMENDED OPERATING CONDITIONS), there is some possibility that output does not change in response to input.

Please evaluate carefully about supply start up or restart after shut down in your application systems.

3) V_B supply voltage

Please use V_B supply voltage within RECOMMENDED OPERATING CONDITIONS ($V_S + 10V < V_B$).

If V_B supply voltage is used on the other conditions, output signal HO may be malfunction.

Please evaluate carefully about V_B supply voltage in your application systems.

4) Processing between IC terminals

As for this product, the terminal of low voltage part and high voltage part are adjacent(The Fifth: LO, The Sixth: V_S).

Therefore, if insulation space distance of those terminals cannot be enough, please coat between those terminals.

ENVIRONMENTAL CONSCIOUSNESS

M81747JFP is compliant with the Restriction of the Use of Certain Hazardous Substances in Electrical and Electronic Equipment (RoHS) directive 2011/65/EU+(EU)2015/863.

<HVIC>

M81747JFP

600V HIGH VOLTAGE HALF BRIDGE DRIVER (for Automotive)

PACKAGE OUTLINE

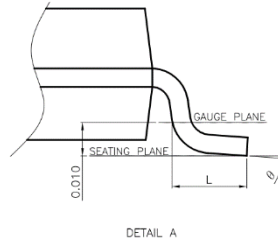
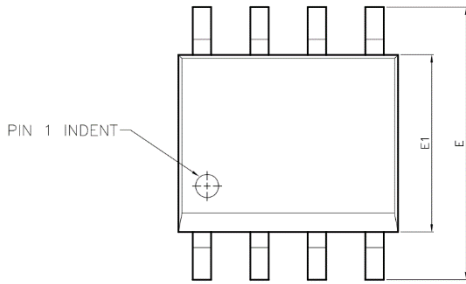

SYMBOLS	DIMENSIONS IN MILLIMETERS		
	MIN	NOM	MAX
A	1.47	1.60	1.73
A1	0.10	—	0.25
A2	—	1.45	—
b	0.33	0.41	0.51
C	0.19	0.20	0.25
D	4.80	4.85	4.95
E	5.80	6.00	6.20
E1	3.80	3.90	4.00
e	—	1.27	—
L	0.40	0.71	1.27
y	—	—	0.076
φ	0°	—	8°

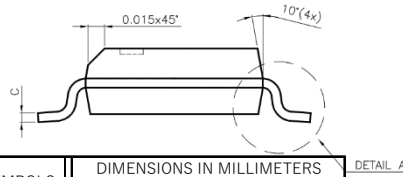
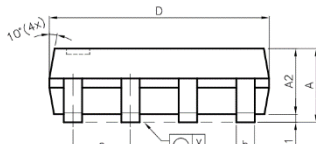

SYMBOLS	DIMENSIONS IN MILLIMETERS		
	MIN	NOM	MAX
e1	—	5.23	—
l2	1.27	—	—
e	—	1.27	—
b2	—	0.76	—

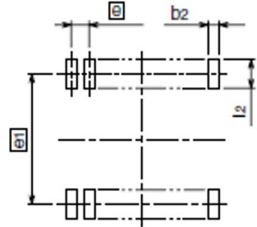

Recommended Mount Pad

The above is one example.
Please design the mount pad with your evaluation.

Important Notice

The information contained in this datasheet shall in no event be regarded as a guarantee of conditions or characteristics. This product has to be used within its specified maximum ratings, and is subject to customer's compliance with any applicable legal requirement, norms and standards.

Except as otherwise explicitly approved by Mitsubishi Electric Corporation in a written document signed by authorized representatives of Mitsubishi Electric Corporation, our products may not be used in any applications where a failure of the product or any consequences of the use thereof can reasonably be expected to result in personal injury.

In usage of power semiconductor, there is always the possibility that trouble may occur with them by the reliability lifetime such as Thermal Cycle or others, or when having assembling stress (e.g. high temperature of reflow process, or rinse after the reflow), or when used under special operating conditions (e.g. rise/fall time of the power supply voltage, or excessive voltage/current injection), or when used under special circumstances (e.g. condensation, high humidity, dusty, salty, highlands, environment with lots of organic matter / corrosive gas / explosive gas, or situations which terminals of semiconductor products receive strong mechanical stress). Therefore, please pay sufficient attention to such circumstances. Further, depending on the technical requirements, our semiconductor products may contain environmental regulation substances, etc. If there is necessity of detailed confirmation, please contact our nearest sales branch or distributor.

The contents or data contained in this datasheet are exclusively intended for technically trained staff. Customer's technical departments should take responsibility to evaluate the suitability of Mitsubishi Electric Corporation product for the intended application and the completeness of the product data with respect to such application. In the customer's research and development, please evaluate it not only with a single semiconductor product but also in the entire system, and judge whether it's applicable. As required, pay close attention to the safety design by installing appropriate fuse or circuit breaker between a high voltage/large current power supply and power semiconductor products(e.g. IGBT, MOSFET) to prevent secondary damage. Please also pay attention to the application note and the related technical information.

Keep safety first in your circuit designs!

Mitsubishi Electric Corporation puts the maximum effort into making semiconductor products better and more reliable, but there is always the possibility that trouble may occur with them. Trouble with semiconductors may lead to personal injury, fire or property damage. Remember to give due consideration to safety when making your circuit designs, with appropriate measures such as (i) placement of substitutive, auxiliary circuits, (ii) use of non-flammable material or (iii) prevention against any malfunction or mishap.

Notes regarding these materials

- These materials are intended as a reference to assist our customers in the selection of the Mitsubishi semiconductor product best suited to the customer's application; they do not convey any license under any intellectual property rights, or any other rights, belonging to Mitsubishi Electric Corporation or a third party.
- Mitsubishi Electric Corporation assumes no responsibility for any damage, or infringement of any third-party's rights, originating in the use of any product data, diagrams, charts, programs, algorithms, or circuit application examples contained in these materials.
- All information contained in these materials, including product data, diagrams, charts, programs and algorithms represents information on products at the time of publication of these materials, and are subject to change by Mitsubishi Electric Corporation without notice due to product improvements or other reasons. It is therefore recommended that customers contact Mitsubishi Electric Corporation or an authorized Mitsubishi Semiconductor product distributor for the latest product information before purchasing a product listed herein.
The information described here may contain technical inaccuracies or typographical errors. Mitsubishi Electric Corporation assumes no responsibility for any damage, liability, or other loss rising from these inaccuracies or errors.
Please also pay attention to information published by Mitsubishi Electric Corporation by various means, including the Mitsubishi Semiconductor home page (<http://www.MitsubishiElectric.com/>).
- When using any or all of the information contained in these materials, including product data, diagrams, charts, programs, and algorithms, please be sure to evaluate all information as a total system before making a final decision on the applicability of the information and products. Mitsubishi Electric Corporation assumes no responsibility for any damage, liability or other loss resulting from the information contained herein.
- Mitsubishi Electric Corporation semiconductors are not designed or manufactured for use in a device or system that is used under circumstances in which human life is potentially at stake. Please contact Mitsubishi Electric Corporation or an authorized Mitsubishi Semiconductor product distributor when considering the use of a product contained herein for any specific purposes, such as apparatus or systems for transportation, vehicular, medical, aerospace, nuclear, or undersea repeater use.
- The prior written approval of Mitsubishi Electric Corporation is necessary to reprint or reproduce in whole or in part these materials.
- If these products or technologies are subject to the Japanese export control restrictions, they must be exported under a license from the Japanese government and cannot be imported into a country other than the approved destination.
Any diversion or re-export contrary to the export control laws and regulations of Japan and/or the country of destination is prohibited.
- Please contact Mitsubishi Electric Corporation or an authorized Mitsubishi Semiconductor product distributor for further details on these materials or the products contained therein.